

# BENY 90X200

I 1990x200(1x)

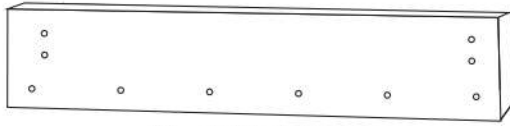

II 902x110(2x)



III 1990x110(1x)

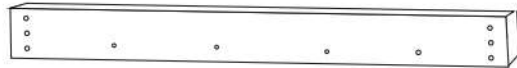

IV 1945x45(2x)

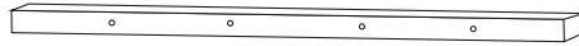

V 900x62 (15x)



VI 73x50 (2x)



1

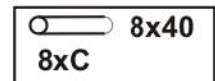
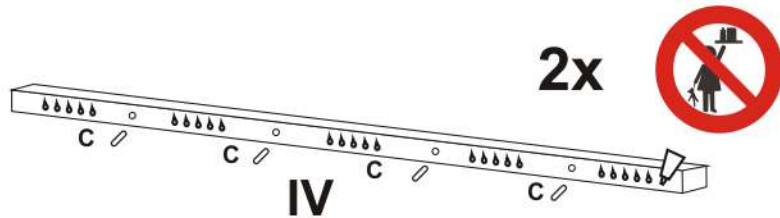

2

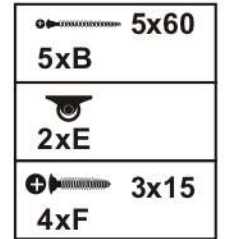
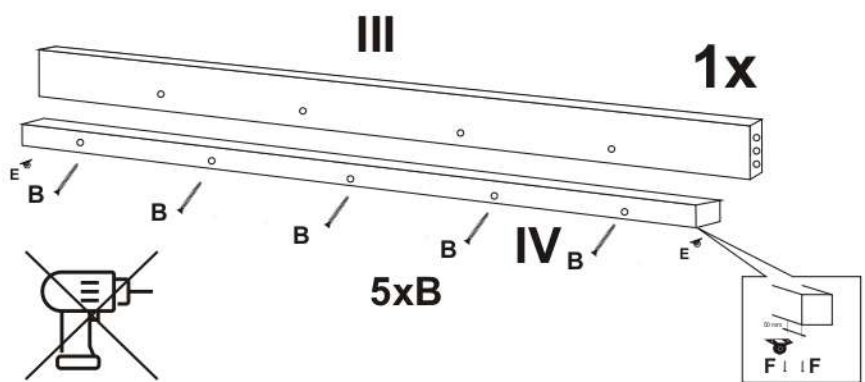

\* SK - LEPIDLO  
CZ - LEPIDLO  
SI - LEPILO  
HR - LJEPILO  
HU - RAGASZTÓ  
RO - LIPICI

|   |      |        |    |
|---|------|--------|----|
| A | 6x70 |        | 8  |
| B | 5x60 |        | 10 |
| C | 8x40 |        | 12 |
| D | 4x30 |        | 30 |
| E |      |        | 4  |
| F | 3x15 |        | 8  |
| G |      |        | 1  |
| H |      | * Glue | 1  |

1

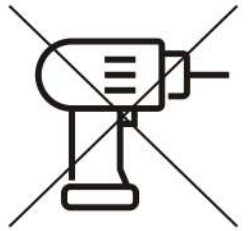

3

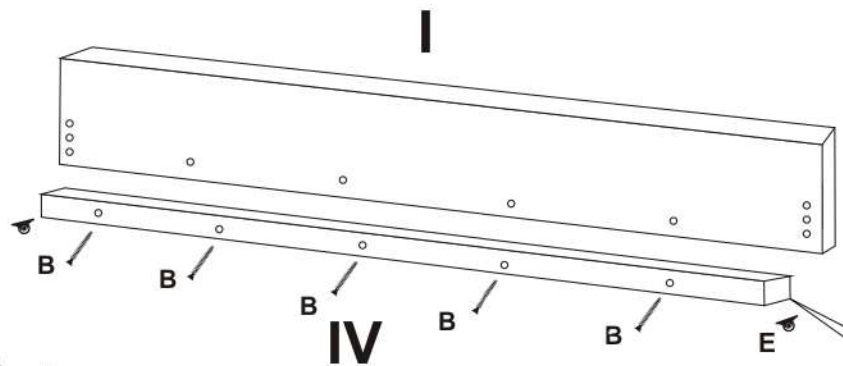

- 5x60
- 5xB
- 2xE
- ⊕ 3x15
- 4xF

4

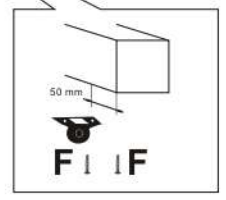
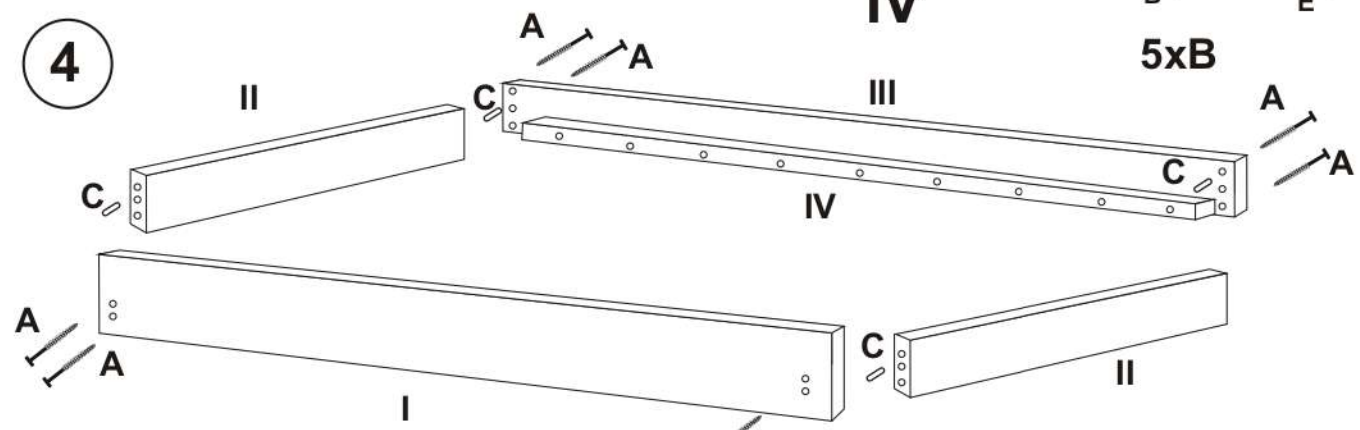

- 8x40
- 4xC
- 6x70
- 8xA

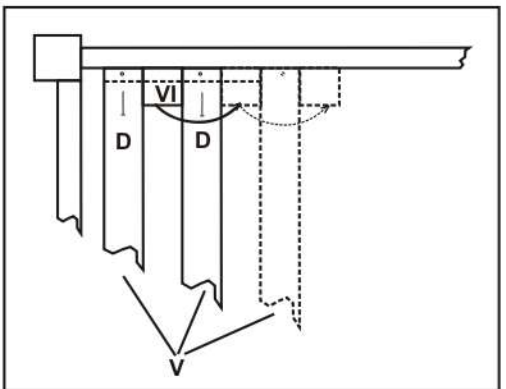

5

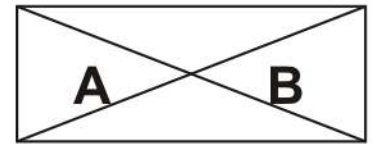
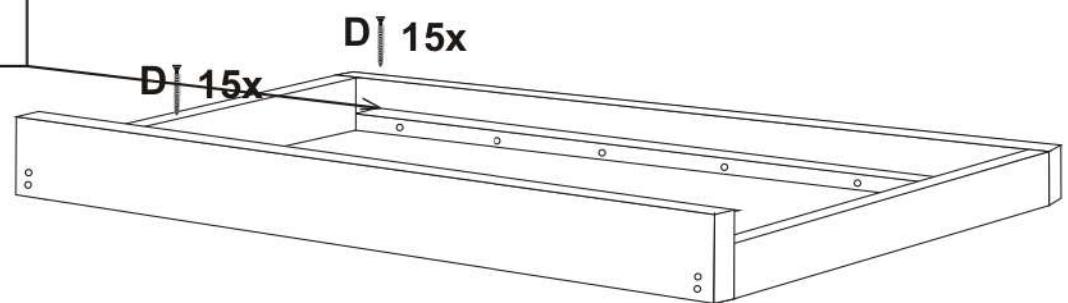

A=B

- ⊕ 4x30
- 30xD